

C-SERIES GRADERS
836C | 836C AWD | 856C | 856C AWD

CASE

CONSTRUCTION



**TIER 4
FINAL**

**A NEW TOP PLAYER
IN OUR TEAM**

www.casece.com

EXPERTS FOR THE REAL WORLD
SINCE 1842

HERITAGE

A TRADITION OF INDUSTRY FIRSTS



EXPERTS FOR THE REAL WORLD SINCE 1842

- 1842** Case is founded.
- 1867** Eisenwerk Gebruder Frisch KG was Founded.
- 1926** Road building equipment production.
- 1934** The First Frisch grader is also the first european motor grader.
- 1936** Dedicated Frisch road building plant in Kissing.
- 1967** First automatic blade guidance based on ultrasonic system.
- 1970** Articulated frame introduction.
- 1972** AWD introduction.
- 1977** Frisch company acquired by Faun.
- 1982** Encapsulated slewing ring introduction.
- 1986** Faun grader operations acquired by Orenstein and Koppel (O&K).
- 1996** Load Sensing hydraulic system introduction and grader production moved to Berlin.
- 2000** High visibility engine hood design introduction.
- 2005** FPT engines introduction and 6 cylinder installation on 13 t grader.
- 2010** All around visibility cab introduction.
- 2013** Low Profile cab introduction.
- 2015** Case branded graders enter the European Market.

POWER TO THE GROUND



LOW EMISSIONS

Tier 4 Final

The patented FPT Hi-eSCR is the key for performance and success. The CASE grader is the only one in the market satisfying the restrictive TIER 4 final demands with SCR-only aftertreatment technology. None of the others can provide such a smart solution hugely cost efficient thanks to the following exclusivities:

- No DPF regeneration during the working activities means no waste of Fuel
- No DPF filter periodical replacement
- No need of double stage aftertreatment DPF+SCR
- The FPT engine implies no gas recirculation improving consequently the combustion efficiency
- Neat engine layout thanks to the after treatment small size
- Lower engine cooling requirement and consequently smaller radiator size for better rear visibility and easy cleaning



DUAL POWER CURVE

Get mor productive at higher speed

The engine is completely application-engineered to power motor graders which require fast torque response to keep high productivity levels. For even higher performances the Dual Power maximizes operation at higher speed thanks to the power curve flattening from 4th gear.



SAFE AND EASY MAINTENANCE

Never so undemanding

Daily maintenance operations have never been so undemanding: all the main check points, on the left hand side of the machine, are easily reachable from ground level. The tandem mudguards are conceived to be the most functional and safer places to fulfil periodical maintenance operations like the air filter cleaning or the oil refill. The smallest aftertreatment package in the market doesn't impact the engine layout sharpness: the emergency maintenance operations will then be faster and less expensive.

C-SERIES MOTOR GRADERS



ERGOPOWER TRANSMISSION WITH TORQUE CONVERTER

Jerk free shifting

The automatic shifting function eases the operator concentration and optimizes the machine performances letting the grader engine work on the most productive area of the power curve. The function combined with the torque converter never reaches the power unit stall, making the real difference from competitors in the grader sector.

100% automatic diff. Lock: the automatic «no-Spin» differential instantaneously transfers the torque from the slipping tyre to the wheel with better grip. The system doesn't require any driver intervention allowing the operator to be focused on the blade movement control.



AWD WITH CREEP MODE DRIVE

Precise at any speed

Creep mode on AWD models: 2 machines in one, the hydrostatic creep mode makes the front speed virtually independent from the engine revolutions: therefore the grader can be used in compaction application reducing the overall fleet deployed in road construction. Independently from the transmission chosen, 4 WD or 6WD, the 836C can be also equipped with 24" tyres: the ideal solution on uneven soils and when a low tyre bumping effect is required.



ROLLER MOUNTED ENCAPSULATED SLEWING RING

Zero friction engineering solutions

Moldboard design revolutionizes and maximizes controllability: very low friction developed during operation, jolt-free high rotation torque for a very smooth and accurate blade rotation and steadiness.

The slewing ring is mounted on roller bearings activated by internal gearing avoiding backlash, wear and supporting high mechanical strain. The exclusive moldboard design, with fewer greasing points, reduces the daily maintenance drastically. During the machine service life, periodical substitution of wear inserts is not required cutting down overall maintenance costs.



"A-SHAPE" FRAME

Stress free structure

The "A-Shape" structure constantly compensates the efforts while working. The typical lateral stress on off-set position are virtually eliminated for longer operating life. The saddle can be hydraulically set on 5 different positions very easily thanks to a pin lock system; the exclusive moldboard geometry enables the operator to rotate the blade over 90° for each working side without any mechanical interference.



MULTI-RADIUS BLADE

Easy material rolling

The infinitely variable radius blade reduces the traction effort, and in finishing operations improves the material mixing effect.



EXTREME PRECISION



LOAD SENSING HYDRAULIC SYSTEM

Flow at your fingertip

The new CASE graders have the most precise hydraulic circuit in the market. With highly responsive and precise controls, the load sensing hydraulics make any operation easy and smooth. A directly activated axial piston pump delivers only the required amount of oil where it is needed, avoiding any power waste. The Control valves provide pressure compensation enabling the moldboard to be lifted or lowered in parallel. A dedicated switch installed on the cab floor allows the operator to obtain maximum output from the hydraulic circuit, independently from the engine revolutions, for faster reactions (Full Flow mode).

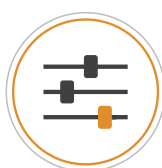

DIRECTLY MOUNTED CONTROL LEVERS

Banning power waste, spinning productivity

The exclusive hydraulic block, directly controlled, reduces any lever free play over the entire grader life, meanwhile the operator can benefit from a direct feed-back of the hydraulic system increasing the working accuracy. The float function, available as an option, lets the oil flow unobstructedly in the cylinders so to let the moldboard naturally follow the ground contour. Independently from CASE certified high quality components, this exclusive hydraulic system has been conceived to ensure always unbeatable performances, fuel saving, reliability and grader controllability.

BLADE CONTROL PREDISPOSITION

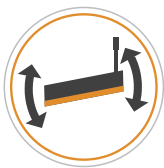

BLADE CONTROL SET UP

Flexible performance

The CASE “800 series” grader can be equipped from factory with the most common blade control installation set up. The unit is delivered to the customer with all the sensors, cables and supports. It’s a real “plug and play” solution: the customer has just to install the antenna and the monitor on the cab and the blade control is ready to work. The system is compatible with different types of controls: Sonic, Laser, GPS or Universal Total Station. The automatic blade control allows even the less skilled operator to get a considerable working capacity from CASE grader, this helps to get the job done faster meaning fewer rounds and always the right amount of material moved. Consequently, grader cost effectiveness in terms of operation and working time.

With CASE control set up each customer can even use blade control devices already installed in other construction units of its fleet making the return on investment more immediate.

The installation of main components in factory provides an easier accessibility and consequently faster maintenance service: this is a guarantee of high manufacturing standard, almost impossible to achieve through aftermarket solutions.



COMFORT RULES

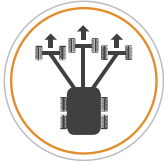

REAR MOUNTED CAB

Aligned with performance

The rear mounted ROPS/FOPS cab offers a highly valuable advantage in comfort and convenience:

- Operators are aware of the articulation angle at all times
- The rear located cab improves visibility on the moldboard
- The cab weight carried on the rear frame emphasizes the machine traction
- Pneumatic and heated seat offered as a standard strengthens operator well-being at work

The wide tinted glass mounted on the front and on the side of the cab provides unobstructed all-around visibility. Even when the driver is working seated, he can have full moldboard visibility till its heel angle. The safety too is improved:

- The new rear view camera guarantees a safer rear visibility and an excellent operator comfort. The driver doesn't have to turn back anymore when he has to drive the machine backward.
- Any obstacle can be easily recognized from a quick look at the wide 7" color screen.



LOW CAB PROFILE

A new Cabin equipped with all "mod cons"

Finally, CASE offers an elegant low profile cab on its graders providing best-in class comfort and visibility while reducing the machine's total height of 180mm, so that there are no transport limitations.



THE ART OF VERSATILITY



HIGH VERSATILITY

Tools for every task

CASE graders can be completed with a wide variety of fittings making them suitable for a great number of applications:

- 3 customizable moldboard widths for each model to easily adapt the pushing power to different material density and working conditions
- Different Moldboard extensions for better lateral material retention in fine grading
- Moldboard overload clutch to preserve frame and moldboard from any unexpected collision, recommended in forestry applications
- Moldboard scarifier for easier light soil preparation in a single pass
- 3 or 5 teeth ripper to better scarify the sturdier soil roots
- front blade for faster dozing operations and for improved productivity in combination with the central blade thanks to the engine power high level
- Specific front counterweight: better machine balance and higher tractive effort
- Rear hydraulic set up providing the right oil flow for additional implements such as compactors, it represents the ideal combination with the exclusive creep mode
- Fuel tank refill pump: easier daily tank refill in any working environment
- Additional lights packages:
 - on the rear counterweight
 - on the lower part of the cab for higher light intensity on the moldboard

MAIN REASONS TO CHOOSE THE C-SERIES



LOAD SENSING HYDRAULIC SYSTEM

- The balanced flow for all applications and for simultaneous moldboard movements.



HIGH VERSATILITY

- The wide variety of options offers, to any customer, the possibility to create a tailored grader suitable for the most demanding applications.



SAFE AND EASY MAINTENANCE

- The easy serviceability is part of CASE DNA: all the main checks can be easily performed from the wide and safe tandem fenders; all the service points are conveniently grouped and positioned.



«A-SHAPE» FRAME

- An optimized effort distribution in any condition ensures long operating life.

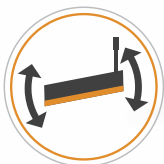

BLADE CONTROL SET UP

- Leading brands plug and play blade control system.



MULTI-RADIUS BLADE

- Lower power absorption and optimized rolling effect.



ROLLER MOUNTED, ENCAPSULATED SLEWING RING

- Maintenance free technology and effortless moldboard rotation.



LOW PROFILE CAB

- Less 180 mm transport height / transport on trucks below 4 mt.-

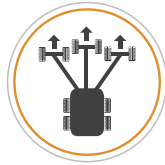

REAR MOUNTED CAB

- Best in class controllability and comfort: the operator is always in line with the working direction.

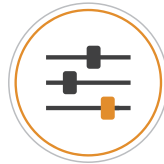

DIRECTLY MOUNTED CONTROL LEVERS

- Better moldboard control over the years, no free play between levers and main control valve.



LOW EMISSIONS

- The exclusive «HI-eSCR» technology, with AdBlue-only aftertreatment, dramatically reduces fuel consumption cutting off the after treatment maintenance costs.



DUAL POWER CURVE

- Higher power rate at high speed (4th gear) increases the grader productivity.



ERGOPOWER TRANSMISSION WITH TORQUE CONVERTER

- Smooth shifting for perfect controllability and automatic mode for stress-free operations.



AWD WITH CREEP MODE DRIVE

- Full traction in any condition and optimized torque transfer adapted to operator needs.

TELEMATICS

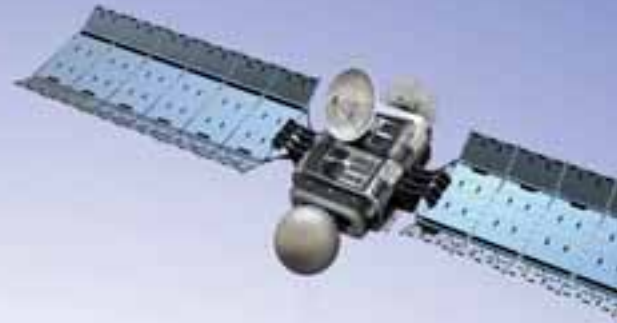

CASE®
CONSTRUCTION

SiteWatch™

THE SCIENCE BIT

The Case SiteWatch telematics system uses a high-tech control unit mounted on each machine to collate information from that machine and from GPS satellites. This data is then sent wirelessly through the mobile communication networks to the Case Telematics Web Portal.

SiteWatch: centralised fleet control benefits at your fingertips

📶 Measure your true asset availability and optimise it

- Eliminate the “phantom fleet”: SiteWatch allows to identify spare units or under loaded machines on each site.
- Become able to reallocate units where they are more needed.
- Forward Maintenance Planning is easier since the actualised working hours are always available.
- Extend the benefits of SiteWatch to the rest of your fleet: SiteWatch can be installed on the units of other brands as well.

📶 Challenge your Total Cost of Ownership!

- Being able to compare the fuel usage of different machine types will allow you choose the right equipment.
- Save on transport costs with planned and grouped maintenance tasks.
- Peace of mind, optimised uptime and lower repair costs: with preventive maintenance you can for example be alerted if the engine needs to be serviced and avoid a disruptive breakdown.
- Be able to compare your asset Return On Investment on different sites.
- Your equipment is used only during working hours. You can set up alerts so that you know if it is in use during the weekend or at night.
- Integrate with the programmed maintenance package, so that you can be sure every machine is at the right place at the right time.

📶 More Safety, Lower Insurance Premium

- Keep thieves away: dissuade them from attacking your asset because it is geo-localised. SiteWatch is hidden so that thieves can't find it quickly.
- Your fleet is used only where you decide. You can define a virtual fence and receive an email when a machine exits that perimeter.



C-SERIES

MOTOR GRADERS

836C - 836C AWD SPECIFICATIONS

ENGINE TIER 4 FINAL "HI-eSCR"

Maximum Power (ISO 14396/ECE R120)
 From 1st to 3rd gear _____ 102 kW/138 hp
 From 4th to 6th gear _____ 115 kW/156 hp
 Governed _____ 2100 rpm
 Make & model _____ NEF 6 cyl. CR TAA 4V
 Aftertreatment system _____ SCR only
 Donaldson air filter with dust ejector _____ std
 Type ___ diesel, common rail, dual power, turbocharged and intercooler
 Displacement _____ 6.7 l
 Number of cylinders _____ 6
 Bore & stroke _____ 104x132 mm
 Maximum torque at 1400 rpm _____ 725 Nm
 Remote engine oil filter for easy replacement
 - 25°C outside temperature start as standard equipment
 The engine complies with 97/68/EC standards TIER 4 Final

TORQUE CONVERTER

Single-stage torque converter integrated into shift gearbox
 Automatic matching of output torque to changing travel conditions
 Converter ratio _____ 1.87: 1
 Cooling by heat exchanger

TRANSMISSION

Full powershift transmission with 6 forward and 3 reverse gears.
 Electric single-lever shift with reverse-lock in ranges 3-6.

Speeds in km/h

Gear	Forwards	Reverse
1.	5.4	5.7
2.	8.3	13.3
3.	12.6	29.2
4.	19.2	-
5.	27.9	-
6.	39.9	-

Tractive effort (adherence coefficient 0.8)

836C _____ 66 kN
 836C AWD _____ 85 kN

AXLE FRONT

Oscillating axle with wheel spindle steering and hydraulic wheel lean adjustment

	836C	836C AWD
Axle oscillation	± 15°	± 15°
Wheel lean	± 21.45°	± 21.45°
Ground clearance	485 mm	485 mm

AXLE REAR TANDEM

CASE tandem grader axle with automatic No-Spin differential
 Oscillating tandem drives with heavy-duty roller chains
 Planetary reduction
 Oscillation _____ ± 15°
 Tandem box dimensions:
 Height _____ 599 mm
 Width _____ 201 mm
 Wall thickness _____ 20 mm
 Chain pitch _____ 50.8 mm
 Tandem wheelbase _____ 1241 mm

ALL WHEEL DRIVE

Selectable in addition to the hydrodynamic rear-wheel drive. Hydrostatic front-wheel drive with E.D.C.V. (Electronic Drive Control Volume). A bi-directional swash plate pump (forward/reverse) drives wheel-hub mounted motors in each of the front wheels. Hydraulic No-Spin differential prevents one-sided wheel spin and proportions torque when cornering. A microprocessor monitors and matches front- and rear-wheel drive forces. A stepless switch allows the operator to adapt front-wheel thrust to existing job conditions. Creep mode as standard: front traction only, for ultra low machine speed.

BRAKES

Hydraulic, dual-circuit accumulator pump braking with 4 oil bath disc brakes acting on tandem-wheels. Parking brake: disc brake acting on transmission.

STEERING

Operated from the adjustable steering and control console. Front-wheel spindle steering, all hydraulic, volume control.

	836C	836C AWD
Steering wheel lock. left/right	40°	40°
Articulated frame with 2 double-flow steering cylinders:		
Articulation angle	± 28°	± 28°
Minimum turning radius:		
across tyres	6600 mm	6800 mm
across front blade	7300 mm	7600 mm

TYRES

405/70 R20 SPT9 Dunlop
 420/75 R20 XMCL TL Michelin
 455/70 R20 SPT9 Dunlop
 405/70 R24 SPT9 Dunlop



XMCL MICHELIN SPT9 DUNLOP

MOLDBOARD CONTROL

"Load Sensing" for maximising functions controllability. Control levers for precision metering of adjustment speed. Pressure compensation in each of the control valve units permits parallel moldboard lifting or simultaneous operation of two other functions, with no disruptive interaction. A pedal allows the operator to switch to max. output for faster functioning (Full Flow Mode). Unlockable check valves maintain lift/cutting angles and wheel lean cylinders constant.

SPECIFICATIONS

A-FRAME

Robust welded box section A-frame.

L-profile cross section _____ 125x120x8 mm

SLEWING RING

Internal gearing, sealed roller-mounted, backlash-free, self-adjusting
Driven by hydraulic motor and moldboard mechanism

Diameter _____ 1150 mm

Action radius _____ 360°

MOLDBOARD

Multiradius wear-resistant, high-grade steel with hardened rounded guides. Replaceable, split main and side blades.

Width _____ 2440/3050/3355 mm

Blade height/thickness _____ 526/15 mm

Cutting edge height/thickness _____ 152/19 mm

Bolt diameter _____ 16 mm

MOLDBOARD SETTINGS

Shifting:

to the right _____ 491 mm

to the left _____ 708 mm

Reach across tyres w/o articulated steering:

right horizontal _____ 1865 mm

left horizontal _____ 1525 mm

Reach across tyres with articulated steering:

right horizontal _____ 2490 mm

left horizontal _____ 2150 mm

Max. slope angle:

right _____ 117°

left _____ 76°

Max. lift height above ground _____ 394 mm

Max. scraping depth _____ 456 mm

Cutting angle adjustment, hydr _____ 49.5°

HYDRAULIC SYSTEM

“Load Sensing” with variable displacement axial piston pump. Zero oil delivery under no-function conditions and hence power savings.

Closed system with pressurised tank. Pressure relief valve.

Hydraulic pump _____ swash plate, variable displacement

Max delivery _____ 94.5 l/min

Max pressure _____ 200 bar

Pressure relief setting _____ 215 bar

FRAME

Front frame: stiff, welded section from high-strength, fine-grain steel

Cross-section _____ 270 x 270 mm

Wall thickness _____ 12 mm

Rear frame _____ torsion resistant frame

Cross-section _____ 220 x 260 mm

CAB

Elastically mounted, noise insulated ROPS/FOPS cab with two swinging doors. Either side access. Tinted glass. Rear-frame mounted cab. Heater/defroster nozzles. Heated and Air Suspended seat.

Low profile Cab option reducing overall grader height by 180 mm.

ROPS according to EEC sample testing _____ ISO 3471

FOPS according to EEC sample testing _____ ISO 3449

Cab noise level _____ 77 dbA

External noise level _____ 102 dbA

ELECTRICAL SYSTEM

Voltage _____ 24 V

Batteries _____ 2 x 100 Ah

Alternator _____ 90 A

Starter _____ 4 kW

CAPACITIES

Lube oil _____ litres

Coolant (Including: cooler and Heater) _____ 12.5

Transmission (including converter and cooling) _____ 32.0

Axle gear _____ 27.0

Tandem _____ 31.0

Worm gear _____ 120.0

Hydraulic tank _____ 2

Hydraulic oil, total: _____ 70.0

836C _____ 170.0

836C AWD _____ 185.0

Fuel tank _____ 278.0

AdBlue tank _____ 54

C-SERIES

MOTOR GRADERS

856C - 856C AWD SPECIFICATIONS

ENGINE TIER 4 FINAL "HI-eSCR"

Maximum Power (ISO 14396/ECE R120)
 From 1st to 3rd gear _____ 129 kW/173 hp
 From 4th to 6th gear _____ 142 kW/190 hp
 Governed _____ 2100 rpm
 Make & model _____ NEF 6 cyl. CR TAA 4V
 Aftertreatment system _____ SCR only
 Donaldson air filter with dust ejector _____ std
 Type ___ diesel, common rail, dual power, turbocharged and intercooler
 Displacement _____ 6.7 l
 Number of cylinders _____ 6
 Bore & stroke _____ 104x132 mm
 Maximum torque at 1400 rpm _____ 850 Nm
 Remote engine oil filter for easy replacement
 - 25°C outside temperature start as standard equipment
 The engine complies with 97/68/EC standards TIER 4 Final

TORQUE CONVERTER

Single-stage torque converter integrated into shift gearbox
 Automatic matching of output torque to changing travel conditions
 Converter ratio _____ 1.91: 1
 Cooling by heat exchanger

TRANSMISSION

Full powershift transmission with 6 forward and 3 reverse gears.
 Electric single-lever shift with reverse-lock in ranges 3-6.

Speeds in km/h

Gear	Forwards	Reverse
1.	5.0	5.4
2.	7.7	12.6
3.	11.8	27.9
4.	17.9	-
5.	26.0	-
6.	38.0	-

Tractive effort (adeherence coefficient 0.8)

856C _____ 95 kN
 856C AWD _____ 117 kN

AXLE FRONT

Oscillating axle with wheel spindle steering and hydraulic wheel lean adjustment

	856C	856C AWD
Axle oscillation	± 15°	± 15°
Wheel lean	± 20.3°	± 20.3°
Ground clearance	554 mm	554 mm

AXLE REAR TANDEM

CASE tandem grader axle with automatic No-Spin differential
 Oscillating tandem drives with heavy-duty roller chains
 Planetary reduction
 Oscillation _____ ± 15°
 Tandem box dimensions:
 Height _____ 590 mm
 Width _____ 199 mm
 Wall thickness _____ 20 mm
 Chain pitch _____ 50.8 mm
 Tandem wheelbase _____ 1572.6 mm

ALL WHEEL DRIVE

Selectable in addition to the hydrodynamic rear-wheel drive. Hydrostatic front-wheel drive with E.D.C.V. (Electronic Drive Control Volume). A bi-directional swash plate pump (forward/reverse) drives wheel-hub mounted motors in each of the front wheels. Hydraulic No-Spin differential prevents one-sided wheel spin and proportions torque when cornering. A microprocessor monitors and matches front- and rear-wheel drive forces. A stepless switch allows the operator to adapt front-wheel thrust to existing job conditions. Creep mode as standard: front traction only, for ultra low machine speed.

BRAKES

Hydraulic dual-circuit accumulator pump braking system with four oil cooled disc brakes. Disc brake acting on transmission.

STEERING

Operated from the adjustable steering and control console. Front-wheel spindle steering, all hydraulic, volume control.

	856C	856C AWD
Steering wheel lock, left/right	42.5°	42.5°
Articulated frame with 2 double-flow steering cylinders:		
Articulation angle	± 28°	± 28°
Minimum turning radius:		
across tyres	7300 mm	7300 mm
across front blade	8100 mm	8000 mm

TYRES

17.5 R25 XHA MICHELIN (transport width<2500 mm)
 17.5 R25 XTLA G2 MICHELIN
 17.5 - 25 EM SGL TL GOODYEAR (transport width<2500 mm)



XHA MICHELIN XTLA MICHELIN SLG GOODYEAR

MOLDBOARD CONTROL

"Load Sensing" for maximising functions controllability. Control levers for precision metering of adjustment speed. Pressure compensation in each of the control valve units permits parallel moldboard lifting or simultaneous operation of two other functions, with no disruptive interaction. A pedal allows the operator to switch to max. output for faster functioning (Full Flow Mode). Unlockable check valves maintain lift/cutting angles and wheel lean cylinders constant.

SPECIFICATIONS

A-FRAME

Robust welded box section A-frame.

L-profile cross section _____ 140x140x10 mm

SLEWING RING

Internal gearing, sealed roller-mounted, backlash-free, self-adjusting
Driven by hydraulic motor and moldboard mechanism

Diameter _____ 1350 mm

Action radius _____ 360°

MOLDBOARD

Multiradius wear-resistant, high-grade steel with hardened rounded guides. Replaceable, split main and side blades.

Width _____ 3350/3665/3960 mm

Blade height/thickness _____ 603/20 mm

Cutting edge height/thickness _____ 152/19 mm

Bolt diameter _____ 16 mm

MOLDBOARD SETTINGS

Shifting:

to the right _____ 755 mm

to the left _____ 645 mm

Reach across tyres w/o articulated steering:

right horizontal _____ 2375 mm

left horizontal _____ 1685 mm

Reach across tyres with articulated steering:

right horizontal _____ 3235 mm

left horizontal _____ 2545 mm

Max. slope angle:

right _____ 100°

left _____ 112°

Max. lift height above ground _____ 480 mm

Max. scraping depth _____ 500 mm

Cutting angle adjustment, hydr _____ 50°

HYDRAULIC SYSTEM

“Load Sensing” with variable displacement axial piston pump. Zero oil delivery under no-function conditions and hence power savings.

Closed system with pressurised tank. Pressure relief valve.

Hydraulic pump _____ swash plate, variable displacement

Max delivery _____ 126 l/min

Max pressure _____ 200 bar

Pressure relief setting _____ 215 bar

FRAME

Front frame: stiff, welded section from high-strength, fine-grain steel

Cross-section _____ 300 x 300 mm

Wall thickness _____ 20 mm

Rear frame _____ torsion resistant frame

Cross-section _____ 260 x 90 mm

CAB

Elastically mounted, noise insulated ROPS/FOPS cab with two swinging doors. Either side access. Tinted glass. Rear-frame mounted cab. Heater/defroster nozzles. Heated and Air Suspended seat.

Low profile Cab option reducing overall grader height by 180 mm.

ROPS according to EEC sample testing _____ ISO 3471

FOPS according to EEC sample testing _____ ISO 3449

Cab noise level _____ 78 dbA

External noise level _____ 101 dbA

ELECTRICAL SYSTEM

Voltage _____ 24 V

Batteries _____ 2 x 100 Ah

Alternator _____ 90 A

Starter _____ 4 kW

CAPACITIES

Lube oil _____ litres

Coolant (Including: cooler and Heater) _____ 12.5

Transmission (including converter and cooling) _____ 32.0

Axle gear _____ 27.0

Tandem _____ 36.0

Worm gear _____ 128.0

Hydraulic tank _____ 2.5

Hydraulic oil, total: _____ 90.0

856C _____ 185.0

856C AWD _____ 200.0

Fuel tank _____ 278.0

AdBlue tank _____ 54

C-SERIES MOTOR GRADERS

GENERAL DIMENSIONS

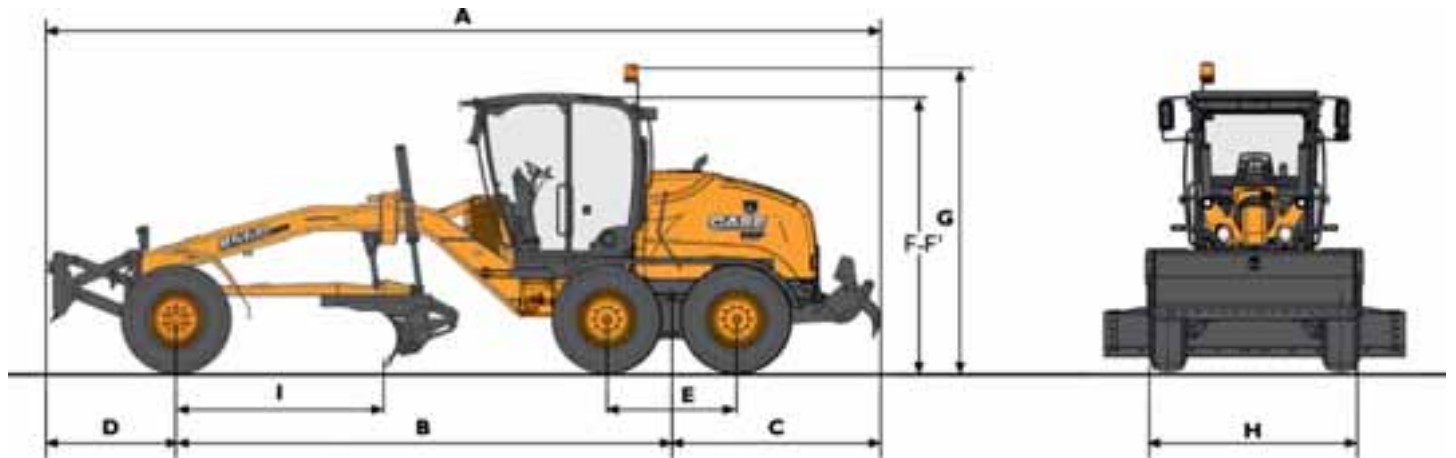

MACHINE WITH:		836C	836C AWD	856C	856C AWD
Front & rear counterweight	kg	11701	12001	14976	15376
Front blade & rear c/w	kg	11805	12105	15140	15540
Front c/w & rear ripper	kg	12005	12305	15407	15807
Front blade & rear ripper	kg	12109	12409	15571	15971
Max. operating weight	kg	12500	12800	16250	16650

With low Profile Cab the weight is reduced by: 35 kg

836C, 836C AWD EQUIPPED WITH:		FRONT & REAR COUNTERWEIGHT	FRONT BLADE & REAR COUNTERWEIGHT	FRONT COUNTERWEIGHT & REAR RIPPER	FRONT BLADE & REAR RIPPER
A Total length	mm	7697	8372	8331	8961
B Wheelbase	mm			5351	
C Rear attachment end	mm		1605		1605
D Front attachment end	mm	762	1436	762	1436
E Tandem base	mm			1241	
F Standard cab height	mm			3240	
F' Low profile cab height	mm			3060	
G Max machine height	mm			3586	
H Width over tyres	mm		2303		2360
I Blade base	mm			1997	

Dimensions referred to a machine equipped with 405/70R20 tires.
Machine height and width over tires may vary with other tires.

856C, 856C AWD EQUIPPED WITH:		FRONT & REAR COUNTERWEIGHT	FRONT BLADE & REAR COUNTERWEIGHT	FRONT COUNTERWEIGHT & REAR RIPPER	FRONT BLADE & REAR RIPPER
A Total length	mm	8592	9317	9285	10044
B Wheelbase	mm			6023	
C Rear attachment end	mm		1785		2458
D Front attachment end	mm	809	1568	809	1568
E Tandem base	mm			1572	
F Standard cab height	mm			3330	
F' Low profile cab height	mm			3150	
G Max machine height	mm			3674	
H Width over tyres	mm		2549		2555
I Blade base	mm			2504	

Dimensions referred to a machine equipped with 17.5R25EM tires.
Machine height and width over tires may vary with other tires.

SPECIFICATIONS

HYDRAULICALLY CONTROLLED FRONT DOZER BLADE

		836C - 836C AWD	856C - 856C AWD
Blade width	mm	2350	2450
Blade height	mm	765	870
Penetration depth	mm	136	174
Max. ground clearance	mm	509	547

HYDRAULICALLY CONTROLLED REAR RIPPER FOR HEAVY DUTY APPLICATIONS

		836C - 836C AWD	856C - 856C AWD
Ripping width	mm	2000	2220
Ripping depth	mm	361	361
Number of shanks	n°	3/5	3/5
Interval of shanks	mm	1000/500	1110/555

THE MOVABLE MOLDBOARD SCARIFIER CAN BE OPERATED IN BOTH DIRECTIONS

		836C - 836C AWD	856C - 856C AWD
Number of shanks	n°	4	6
Scarifying width	mm	900	1100
RIPPING TRACK DISPLACEMENT			
Left	mm	420	580
Right	mm	950	1200
Scarifying depth	mm	134	78

STANDARD EQUIPMENT

- Battery main switch
- Cab equipped with two fully swinging doors for both side access, tinted safety glasses, front and rear sunshield
- Caliper disc parking brake operating on transmission
- NEF Tier 4 Final engine with electronic management and “DualPower”
- SCR only exhaust gas aftertreatment
- Cold start
- Control levers for precise and simultaneous moldboard operations
- Front counterweight
- Front & rear fenders
- Front wheel spindle steering with adjustable steering column
- Heating system
- High grade steel moldboard with hardened rounded guides
- Hydraulic & dual-circuit accumulator brake system operating on tandem wheels
- Hydraulically adjustable for 90° bank slope
- Hydrostatic front-wheel drive with E.D.C.V. Electronic Drive *
- Control Volume & hydraulic differential *
- Internal gearing, sealed, backlash-free & self-adjusting slewing ring operating on 360°
- “Load Sensing” hydraulic system with variable displacement pump
- Moldboard cutting angle hydraulically adjustable
- Oscillating front axle with hydraulic lean adjustment
- Oscillating tandem axle with automatic no-spin differential
- Powershift transmission with 6 forward & 3 reverse speeds, with integrated torque converter
- Rear counterweight
- Road traffic lights
- Rops/Fops suspended cab, mounted on rear frame
- Standard cab
- Heated and Air Suspended seat
- Creep mode “AWD” version only

* Only on 836C AWD & 856C AWD

OPTIONS

- Air conditioning
- Back-up alarm
- Biological hydraulic oil
- Floating valve for moldboard
- Front lights on cab
- Fuel refilling pump (50 l/min)
- Left & right moldboard side plates
- Low profile cab
- Overload clutch on moldboard
- Parallel front blade
- Rear lights on cab
- 3 or 5 teeth rear ripper
- 3 or 5 teeth rear ripper with protection device
- Scarifier on moldboard
- Right moldboard extension
- Rotating beacon
- Tow coupling
- CASE “SiteWatch”
- Rear view Camera with 7” monitor
- Blade control predisposition (Leica, Topcon, Trimble)
- Front counterweight for 836C and 836C AWD (510 kg)
- Front counterweight for 856C and 856C AWD (763 kg)
- Tool box

Note: standard and optional equipment may vary by country. Consult your CASE dealer for specific details.

www.casece.com

EXPERTS FOR THE REAL WORLD
SINCE 1842

CASE
CONSTRUCTION



**CASE CONSTRUCTION EQUIPMENT
CONTACT INFORMATION**

HANLON CASE

Highlands
Campton
Bedford
SG17 5NZ

01462 813301
info@hanlon-case.co.uk
www.hanlon-case.co.uk

NOTE: Standard and optional fittings can vary according to the demands and specific regulations of each country. The illustrations may include optional rather than standard fittings - consult your Case dealer. Furthermore, CNH Industrial reserves the right to modify machine specifications without incurring any obligation relating to such changes.

Conforms to directive 2006/42/EC

CASE Customer Assistance
00800-2273-7373

The call is free from a land line.
Check in advance with your Mobile Operator
if you will be charged.

